

UTS SALES AND REPAIRS

A SAFER WAY TO REACH NEW HEIGHTS

Single Width Tower
1.8m Long x 0.85m Wide

Working Height
3.2m

Platform Height
1.2m

Tower Components

Item	Description	Quantity
1	Locking Caster	4
2	Adjustable Leg	4
3	2 Rung Ladder Frame	0
4	2 Rung Span Frame	0
5	3 Rung Ladder Frame	0
6	3 Rung Span Frame	0
7	4 Rung Ladder Frame	1
8	4 Rung Span Frame	1
9	1.8m Trapdoor Platform	1
10	1.8m Fixed Platform	0
11	1.8m Horizontal Brace	6
12	2.1m Diagonal Brace	2
13	Small Stabiliser	0
14	Large Stabiliser	0
15	Folding Toeboard	1

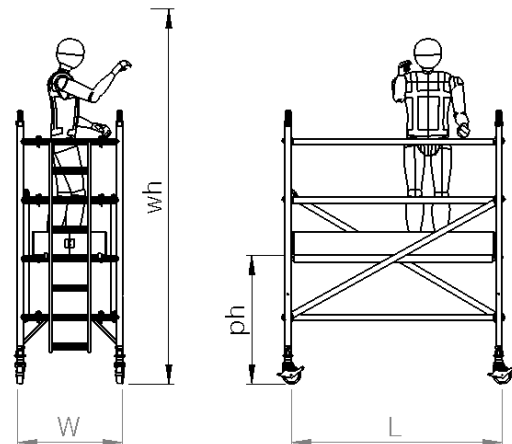

Technical information:

Base Dimensions:	(L)1.8m X (W)0.85m
Maximum Platform Height (ph):	1.2m
Maximum Working Height (wh):	3.2m
Maximum Working Load Per Platform:	275kg
Maximum Working Load Per Tower: (including tower weight)	950kg
Weight:	83.7kg

Example picture of a 1450 1.8m 2.2m Platform Height GRP Tower

01227 860085
Mon-Fri, 8am until 5pm

For More Information:
info@towersandpodiums.co.uk
We reply within 1 hour
Mon-Fri, 8am until 5pm



UTS SALES AND REPAIRS

A SAFER WAY TO REACH NEW HEIGHTS

Single Width Tower
1.8m Long x 0.85m Wide

Working Height
3.7m

Platform Height
1.7m

Tower Components

Item	Description	Quantity
1	Locking Caster	4
2	Adjustable Leg	4
3	2 Rung Ladder Frame	1
4	2 Rung Span Frame	1
5	3 Rung Ladder Frame	1
6	3 Rung Span Frame	1
7	4 Rung Ladder Frame	0
8	4 Rung Span Frame	0
9	1.8m Trapdoor Platform	1
10	1.8m Fixed Platform	0
11	1.8m Horizontal Brace	6
12	2.1m Diagonal Brace	3
13	Small Stabiliser	0
14	Large Stabiliser	0
15	Folding Toeboard	1

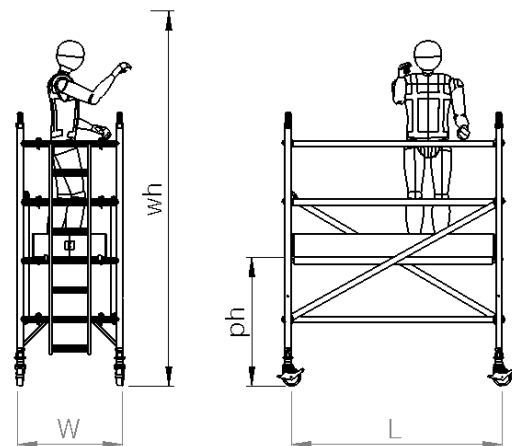

Technical information:

Base Dimensions:	(L)1.8m X (W)0.85m
Maximum Platform Height (ph):	1.7m
Maximum Working Height (wh):	3.7m
Maximum Working Load Per Platform:	275kg
Maximum Working Load Per Tower: (including tower weight)	950kg
Weight:	91.7kg

Example picture of a 1450 1.8m 2.2m Platform Height GRP Tower

01227 860085
Mon-Fri, 8am until 5pm

For More Information:
info@towersandpodiums.co.uk
We reply within 1 hour
Mon-Fri, 8am until 5pm



UTS SALES AND REPAIRS

A SAFER WAY TO REACH NEW HEIGHTS

Single Width Tower
1.8m Long x 0.85m Wide

Working Height
4.2m

Platform Height
2.2m

Tower Components

Item	Description	Quantity
1	Locking Caster	4
2	Adjustable Leg	4
3	2 Rung Ladder Frame	1
4	2 Rung Span Frame	1
5	3 Rung Ladder Frame	0
6	3 Rung Span Frame	0
7	4 Rung Ladder Frame	1
8	4 Rung Span Frame	1
9	1.8m Trapdoor Platform	1
10	1.8m Fixed Platform	0
11	1.8m Horizontal Brace	6
12	2.1m Diagonal Brace	3
13	Small Stabiliser	0
14	Large Stabiliser	0
15	Folding Toeboard	1

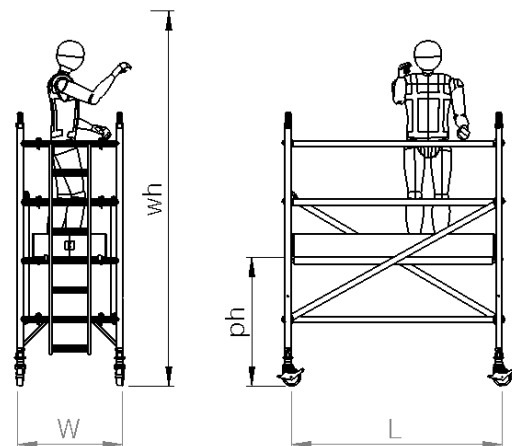

Technical information:

Base Dimensions:	(L)1.8m X (W)0.85m
Maximum Platform Height (ph):	2.2m
Maximum Working Height (wh):	4.2m
Maximum Working Load Per Platform:	275kg
Maximum Working Load Per Tower: (including tower weight)	950kg
Weight:	97.1kg

Example picture of a 1450 1.8m 2.2m Platform Height GRP Tower

01227 860085
Mon-Fri, 8am until 5pm

For More Information:
info@towersandpodiums.co.uk
We reply within 1 hour
Mon-Fri, 8am until 5pm



UTS SALES AND REPAIRS

A SAFER WAY TO REACH NEW HEIGHTS

Single Width Tower
1.8m Long x 0.85m Wide

Working Height
4.7m

Platform Height
2.7m

Tower Components

Item	Description	Quantity
1	Locking Caster	4
2	Adjustable Leg	4
3	2 Rung Ladder Frame	0
4	2 Rung Span Frame	0
5	3 Rung Ladder Frame	1
6	3 Rung Span Frame	1
7	4 Rung Ladder Frame	1
8	4 Rung Span Frame	1
9	1.8m Trapdoor Platform	2
10	1.8m Fixed Platform	0
11	1.8m Horizontal Brace	6
12	2.1m Diagonal Brace	4
13	Small Stabiliser	4
14	Large Stabiliser	0
15	Folding Toeboard	1

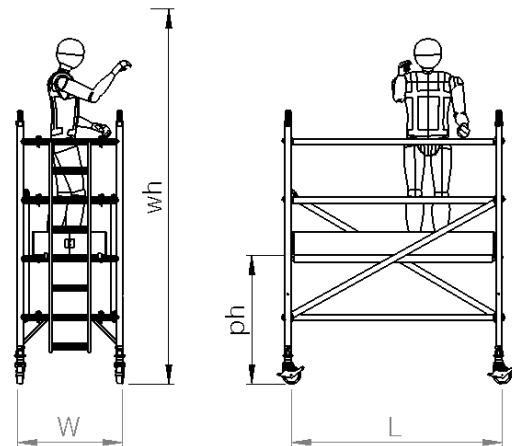

Technical information:

Base Dimensions:	(L)1.8m X (W)0.85m
Maximum Platform Height (ph):	2.7m
Maximum Working Height (wh):	4.7m
Maximum Working Load Per Platform:	275kg
Maximum Working Load Per Tower: (including tower weight)	950kg
Weight:	140.8kg

Example picture of a 1450 1.8m 2.2m Platform Height GRP Tower

01227 860085
Mon-Fri, 8am until 5pm

For More Information:
info@towersandpodiums.co.uk
We reply within 1 hour
Mon-Fri, 8am until 5pm



UTS SALES AND REPAIRS

A SAFER WAY TO REACH NEW HEIGHTS

Single Width Tower
1.8m Long x 0.85m Wide

Working Height
5.2m

Platform Height
3.2m

Tower Components

Item	Description	Quantity
1	Locking Caster	4
2	Adjustable Leg	4
3	2 Rung Ladder Frame	0
4	2 Rung Span Frame	0
5	3 Rung Ladder Frame	0
6	3 Rung Span Frame	0
7	4 Rung Ladder Frame	2
8	4 Rung Span Frame	2
9	1.8m Trapdoor Platform	2
10	1.8m Fixed Platform	0
11	1.8m Horizontal Brace	10
12	2.1m Diagonal Brace	5
13	Small Stabiliser	4
14	Large Stabiliser	0
15	Folding Toeboard	1

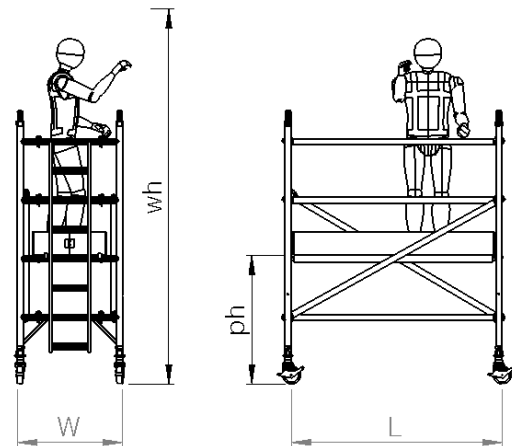

Technical information:

Base Dimensions:	(L)1.8m X (W)0.85m
Maximum Platform Height (ph):	3.2m
Maximum Working Height (wh):	5.2m
Maximum Working Load Per Platform:	275kg
Maximum Working Load Per Tower: (including tower weight)	950kg
Weight:	156.4kg

Example picture of a 1450 1.8m 2.2m Platform Height GRP Tower

01227 860085
Mon-Fri, 8am until 5pm

For More Information:
info@towersandpodiums.co.uk
We reply within 1 hour
Mon-Fri, 8am until 5pm



UTS SALES AND REPAIRS

A SAFER WAY TO REACH NEW HEIGHTS

Single Width Tower
1.8m Long x 0.85m Wide

Working Height
5.7m

Platform Height
3.7m

Tower Components

Item	Description	Quantity
1	Locking Caster	4
2	Adjustable Leg	4
3	2 Rung Ladder Frame	1
4	2 Rung Span Frame	1
5	3 Rung Ladder Frame	1
6	3 Rung Span Frame	1
7	4 Rung Ladder Frame	1
8	4 Rung Span Frame	1
9	1.8m Trapdoor Platform	2
10	1.8m Fixed Platform	0
11	1.8m Horizontal Brace	10
12	2.1m Diagonal Brace	6
13	Small Stabiliser	4
14	Large Stabiliser	0
15	Folding Toeboard	1

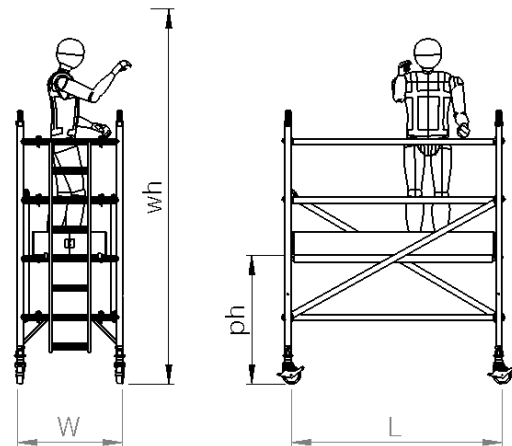

Technical information:

Base Dimensions:	(L)1.8m X (W)0.85m
Maximum Platform Height (ph):	3.7m
Maximum Working Height (wh):	5.7m
Maximum Working Load Per Platform:	275kg
Maximum Working Load Per Tower: (including tower weight)	950kg
Weight:	164.5kg

Example picture of a 1450 1.8m 2.2m Platform Height GRP Tower

01227 860085
Mon-Fri, 8am until 5pm

For More Information:
info@towersandpodiums.co.uk
We reply within 1 hour
Mon-Fri, 8am until 5pm



UTS SALES AND REPAIRS

A SAFER WAY TO REACH NEW HEIGHTS

Single Width Tower
1.8m Long x 0.85m Wide

Working Height
6.2m

Platform Height
4.2m

Tower Components

Item	Description	Quantity
1	Locking Caster	4
2	Adjustable Leg	4
3	2 Rung Ladder Frame	1
4	2 Rung Span Frame	1
5	3 Rung Ladder Frame	0
6	3 Rung Span Frame	0
7	4 Rung Ladder Frame	2
8	4 Rung Span Frame	2
9	1.8m Trapdoor Platform	2
10	1.8m Fixed Platform	0
11	1.8m Horizontal Brace	10
12	2.1m Diagonal Brace	7
13	Small Stabiliser	4
14	Large Stabiliser	0
15	Folding Toeboard	1

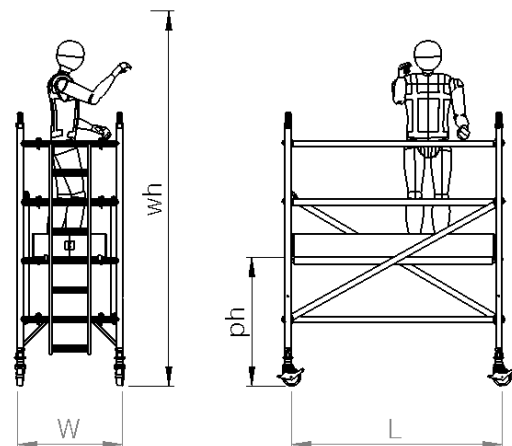

Technical information:

Base Dimensions:	(L)1.8m X (W)0.85m
Maximum Platform Height (ph):	4.2m
Maximum Working Height (wh):	6.2m
Maximum Working Load Per Platform:	275kg
Maximum Working Load Per Tower: (including tower weight)	950kg
Weight:	172.1kg

Example picture of a 1450 1.8m 2.2m Platform Height GRP Tower

01227 860085
Mon-Fri, 8am until 5pm

For More Information:
info@towersandpodiums.co.uk
We reply within 1 hour
Mon-Fri, 8am until 5pm



UTS SALES AND REPAIRS

A SAFER WAY TO REACH NEW HEIGHTS

Single Width Tower
1.8m Long x 0.85m Wide

Working Height
6.7m

Platform Height
4.7m

Tower Components

Item	Description	Quantity
1	Locking Caster	4
2	Adjustable Leg	4
3	2 Rung Ladder Frame	0
4	2 Rung Span Frame	0
5	3 Rung Ladder Frame	1
6	3 Rung Span Frame	1
7	4 Rung Ladder Frame	2
8	4 Rung Span Frame	2
9	1.8m Trapdoor Platform	2
10	1.8m Fixed Platform	0
11	1.8m Horizontal Brace	10
12	2.1m Diagonal Brace	8
13	Small Stabiliser	0
14	Large Stabiliser	4
15	Folding Toeboard	1

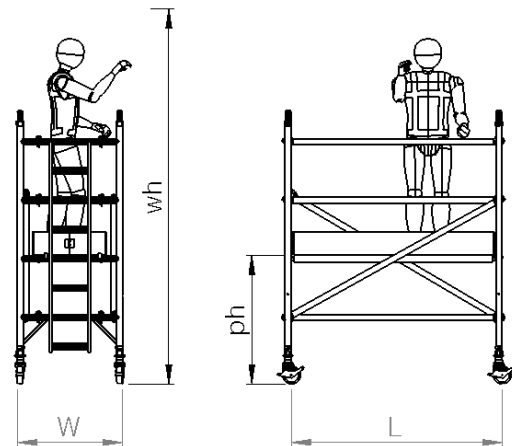

Technical information:

Base Dimensions:	(L)1.8m X (W)0.85m
Maximum Platform Height (ph):	4.7m
Maximum Working Height (wh):	6.7m
Maximum Working Load Per Platform:	275kg
Maximum Working Load Per Tower: (including tower weight)	950kg
Weight:	181.5kg

Example picture of a 1450 1.8m 2.2m Platform Height GRP Tower

01227 860085
Mon-Fri, 8am until 5pm

For More Information:
info@towersandpodiums.co.uk
We reply within 1 hour
Mon-Fri, 8am until 5pm



UTS SALES AND REPAIRS

A SAFER WAY TO REACH NEW HEIGHTS

Single Width Tower
1.8m Long x 0.85m Wide

Working Height
7.2m

Platform Height
5.2m

Tower Components

Item	Description	Quantity
1	Locking Caster	4
2	Adjustable Leg	4
3	2 Rung Ladder Frame	0
4	2 Rung Span Frame	0
5	3 Rung Ladder Frame	0
6	3 Rung Span Frame	0
7	4 Rung Ladder Frame	3
8	4 Rung Span Frame	3
9	1.8m Trapdoor Platform	3
10	1.8m Fixed Platform	0
11	1.8m Horizontal Brace	14
12	2.1m Diagonal Brace	9
13	Small Stabiliser	0
14	Large Stabiliser	4
15	Folding Toeboard	1

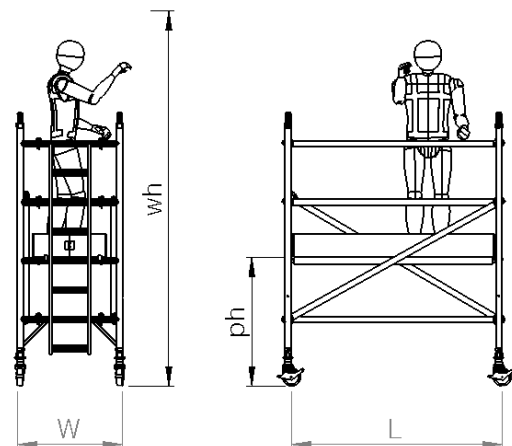

Technical information:

Base Dimensions:	(L)1.8m X (W)0.85m
Maximum Platform Height (ph):	5.2m
Maximum Working Height (wh):	7.2m
Maximum Working Load Per Platform:	275kg
Maximum Working Load Per Tower: (including tower weight)	950kg
Weight:	215.7kg

Example picture of a 1450 1.8m 2.2m Platform Height GRP Tower

01227 860085
Mon-Fri, 8am until 5pm

For More Information:
info@towersandpodiums.co.uk
We reply within 1 hour
Mon-Fri, 8am until 5pm



UTS SALES AND REPAIRS

A SAFER WAY TO REACH NEW HEIGHTS

Single Width Tower
1.8m Long x 0.85m Wide

Working Height
7.7m

Platform Height
5.7m

Tower Components

Item	Description	Quantity
1	Locking Caster	4
2	Adjustable Leg	4
3	2 Rung Ladder Frame	1
4	2 Rung Span Frame	1
5	3 Rung Ladder Frame	1
6	3 Rung Span Frame	1
7	4 Rung Ladder Frame	2
8	4 Rung Span Frame	2
9	1.8m Trapdoor Platform	3
10	1.8m Fixed Platform	0
11	1.8m Horizontal Brace	14
12	2.1m Diagonal Brace	10
13	Small Stabiliser	0
14	Large Stabiliser	4
15	Folding Toeboard	1

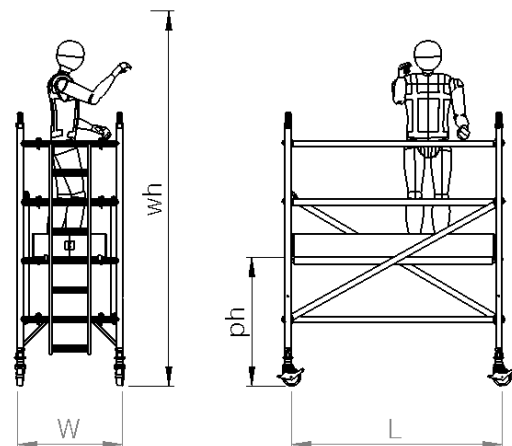

Technical information:

Base Dimensions:	(L)1.8m X (W)0.85m
Maximum Platform Height (ph):	5.7m
Maximum Working Height (wh):	7.7m
Maximum Working Load Per Platform:	275kg
Maximum Working Load Per Tower: (including tower weight)	950kg
Weight:	223.8kg

Example picture of a 1450 1.8m 2.2m Platform Height GRP Tower

01227 860085
Mon-Fri, 8am until 5pm

For More Information:
info@towersandpodiums.co.uk
We reply within 1 hour
Mon-Fri, 8am until 5pm



UTS SALES AND REPAIRS

A SAFER WAY TO REACH NEW HEIGHTS

Single Width Tower
1.8m Long x 0.85m Wide

Working Height
8.2m

Platform Height
6.2m

Tower Components

Item	Description	Quantity
1	Locking Caster	4
2	Adjustable Leg	4
3	2 Rung Ladder Frame	1
4	2 Rung Span Frame	1
5	3 Rung Ladder Frame	0
6	3 Rung Span Frame	0
7	4 Rung Ladder Frame	3
8	4 Rung Span Frame	3
9	1.8m Trapdoor Platform	3
10	1.8m Fixed Platform	0
11	1.8m Horizontal Brace	14
12	2.1m Diagonal Brace	11
13	Small Stabiliser	0
14	Large Stabiliser	4
15	Folding Toeboard	1

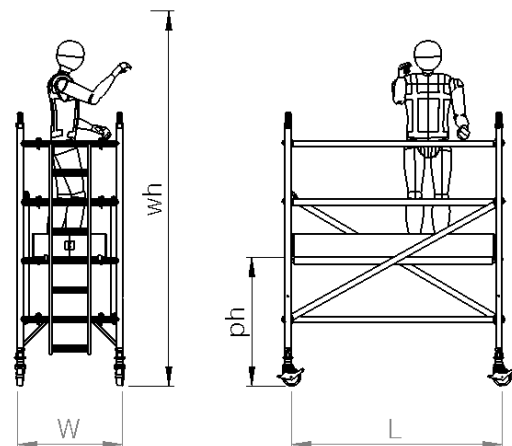

Technical information:

Base Dimensions:	(L)1.8m X (W)0.85m
Maximum Platform Height (ph):	6.2m
Maximum Working Height (wh):	8.2m
Maximum Working Load Per Platform:	275kg
Maximum Working Load Per Tower: (including tower weight)	950kg
Weight:	231.4kg

Example picture of a 1450 1.8m 2.2m Platform Height GRP Tower

01227 860085
Mon-Fri, 8am until 5pm

For More Information:
info@towersandpodiums.co.uk
We reply within 1 hour
Mon-Fri, 8am until 5pm



UTS SALES AND REPAIRS

A SAFER WAY TO REACH NEW HEIGHTS

Single Width Tower
1.8m Long x 0.85m Wide

Working Height
8.7m

Platform Height
6.7m

Tower Components

Item	Description	Quantity
1	Locking Caster	4
2	Adjustable Leg	4
3	2 Rung Ladder Frame	0
4	2 Rung Span Frame	0
5	3 Rung Ladder Frame	1
6	3 Rung Span Frame	1
7	4 Rung Ladder Frame	3
8	4 Rung Span Frame	3
9	1.8m Trapdoor Platform	3
10	1.8m Fixed Platform	0
11	1.8m Horizontal Brace	14
12	2.1m Diagonal Brace	12
13	Small Stabiliser	0
14	Large Stabiliser	4
15	Folding Toeboard	1

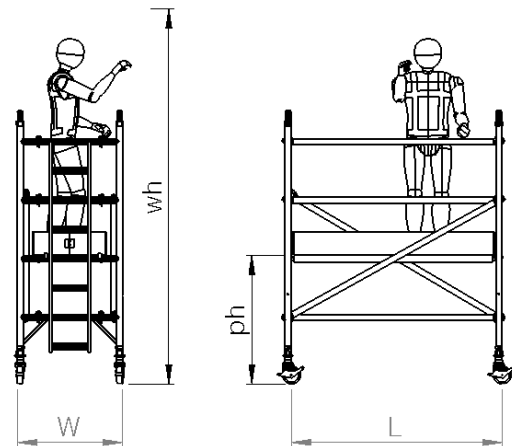

Technical information:

Base Dimensions:	(L)1.8m X (W)0.85m
Maximum Platform Height (ph):	6.7m
Maximum Working Height (wh):	8.7m
Maximum Working Load Per Platform:	275kg
Maximum Working Load Per Tower: (including tower weight)	950kg
Weight:	237.7kg

Example picture of a 1450 1.8m 2.2m Platform Height GRP Tower

01227 860085
Mon-Fri, 8am until 5pm

For More Information:
info@towersandpodiums.co.uk
We reply within 1 hour
Mon-Fri, 8am until 5pm



UTS SALES AND REPAIRS

A SAFER WAY TO REACH NEW HEIGHTS

Single Width Tower
1.8m Long x 0.85m Wide

Working Height
9.2m

Platform Height
7.2m

Tower Components

Item	Description	Quantity
1	Locking Caster	4
2	Adjustable Leg	4
3	2 Rung Ladder Frame	0
4	2 Rung Span Frame	0
5	3 Rung Ladder Frame	0
6	3 Rung Span Frame	0
7	4 Rung Ladder Frame	4
8	4 Rung Span Frame	4
9	1.8m Trapdoor Platform	4
10	1.8m Fixed Platform	0
11	1.8m Horizontal Brace	18
12	2.1m Diagonal Brace	13
13	Small Stabiliser	0
14	Large Stabiliser	4
15	Folding Toeboard	1

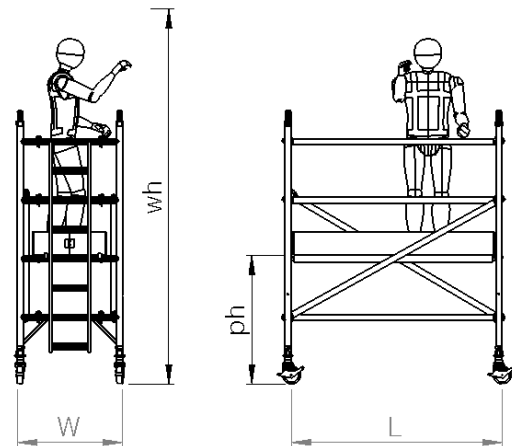

Technical information:

Base Dimensions:	(L)1.8m X (W)0.85m
Maximum Platform Height (ph):	7.2m
Maximum Working Height (wh):	9.2m
Maximum Working Load Per Platform:	275kg
Maximum Working Load Per Tower: (including tower weight)	950kg
Weight:	271.8kg

Example picture of a 1450 1.8m 2.2m Platform Height GRP Tower

01227 860085
Mon-Fri, 8am until 5pm

For More Information:
info@towersandpodiums.co.uk
We reply within 1 hour
Mon-Fri, 8am until 5pm



UTS SALES AND REPAIRS

A SAFER WAY TO REACH NEW HEIGHTS

Single Width Tower
1.8m Long x 0.85m Wide

Working Height
9.7m

Platform Height
7.7m

Tower Components

Item	Description	Quantity
1	Locking Caster	4
2	Adjustable Leg	4
3	2 Rung Ladder Frame	1
4	2 Rung Span Frame	1
5	3 Rung Ladder Frame	1
6	3 Rung Span Frame	1
7	4 Rung Ladder Frame	3
8	4 Rung Span Frame	3
9	1.8m Trapdoor Platform	4
10	1.8m Fixed Platform	0
11	1.8m Horizontal Brace	18
12	2.1m Diagonal Brace	14
13	Small Stabiliser	0
14	Large Stabiliser	4
15	Folding Toeboard	1

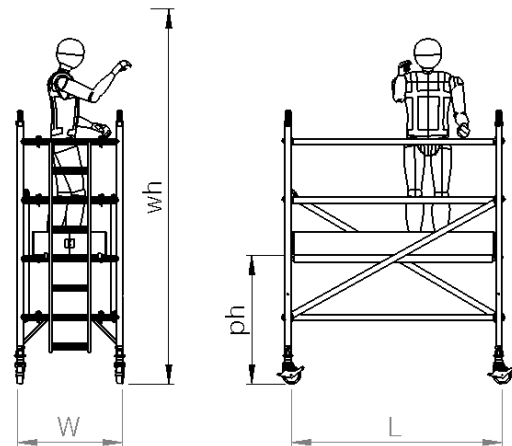

Technical information:

Base Dimensions:	(L)1.8m X (W)0.85m
Maximum Platform Height (ph):	7.7m
Maximum Working Height (wh):	9.7m
Maximum Working Load Per Platform:	275kg
Maximum Working Load Per Tower: (including tower weight)	950kg
Weight:	279.9kg

Example picture of a 1450 1.8m 2.2m Platform Height GRP Tower

01227 860085
Mon-Fri, 8am until 5pm

For More Information:
info@towersandpodiums.co.uk
We reply within 1 hour
Mon-Fri, 8am until 5pm



UTS SALES AND REPAIRS

A SAFER WAY TO REACH NEW HEIGHTS

Single Width Tower
1.8m Long x 0.85m Wide

Working Height
10.2m

Platform Height
8.2m

Tower Components

Item	Description	Quantity
1	Locking Caster	4
2	Adjustable Leg	4
3	2 Rung Ladder Frame	1
4	2 Rung Span Frame	1
5	3 Rung Ladder Frame	0
6	3 Rung Span Frame	0
7	4 Rung Ladder Frame	4
8	4 Rung Span Frame	4
9	1.8m Trapdoor Platform	4
10	1.8m Fixed Platform	0
11	1.8m Horizontal Brace	18
12	2.1m Diagonal Brace	15
13	Small Stabiliser	0
14	Large Stabiliser	4
15	Folding Toeboard	1

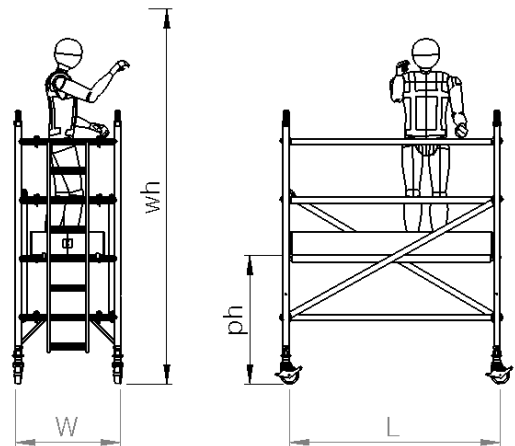

Technical information:

Base Dimensions:	(L)1.8m X (W)0.85m
Maximum Platform Height (ph):	8.2m
Maximum Working Height (wh):	10.2m
Maximum Working Load Per Platform:	275kg
Maximum Working Load Per Tower: (including tower weight)	950kg
Weight:	287.5kg

Example picture of a 1450 1.8m 2.2m Platform Height GRP Tower

01227 860085
Mon-Fri, 8am until 5pm

For More Information:
info@towersandpodiums.co.uk
We reply within 1 hour
Mon-Fri, 8am until 5pm



UTS SALES AND REPAIRS

A SAFER WAY TO REACH NEW HEIGHTS

Single Width Tower
1.8m Long x 0.85m Wide

Working Height
10.7m

Platform Height
8.7m

Tower Components

Item	Description	Quantity
1	Locking Caster	4
2	Adjustable Leg	4
3	2 Rung Ladder Frame	0
4	2 Rung Span Frame	0
5	3 Rung Ladder Frame	1
6	3 Rung Span Frame	1
7	4 Rung Ladder Frame	4
8	4 Rung Span Frame	4
9	1.8m Trapdoor Platform	4
10	1.8m Fixed Platform	0
11	1.8m Horizontal Brace	18
12	2.1m Diagonal Brace	16
13	Small Stabiliser	0
14	Large Stabiliser	4
15	Folding Toeboard	1

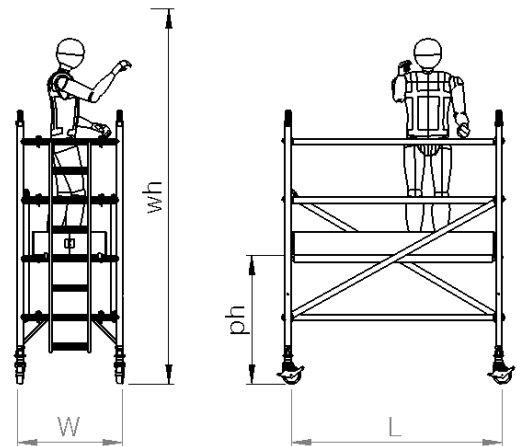

Technical information:

Base Dimensions:	(L)1.8m X (W)0.85m
Maximum Platform Height (ph):	8.7m
Maximum Working Height (wh):	10.7m
Maximum Working Load Per Platform:	275kg
Maximum Working Load Per Tower: (including tower weight)	950kg
Weight:	293.8kg

Example picture of a 1450 1.8m 2.2m Platform Height GRP Tower

01227 860085
Mon-Fri, 8am until 5pm

For More Information:
info@towersandpodiums.co.uk
We reply within 1 hour
Mon-Fri, 8am until 5pm



UTS SALES AND REPAIRS

A SAFER WAY TO REACH NEW HEIGHTS

Single Width Tower
1.8m Long x 0.85m Wide

Working Height
11.2m

Platform Height
9.2m

Tower Components

Item	Description	Quantity
1	Locking Caster	4
2	Adjustable Leg	4
3	2 Rung Ladder Frame	0
4	2 Rung Span Frame	0
5	3 Rung Ladder Frame	0
6	3 Rung Span Frame	0
7	4 Rung Ladder Frame	5
8	4 Rung Span Frame	5
9	1.8m Trapdoor Platform	5
10	1.8m Fixed Platform	0
11	1.8m Horizontal Brace	22
12	2.1m Diagonal Brace	17
13	Small Stabiliser	0
14	Large Stabiliser	4
15	Folding Toeboard	1

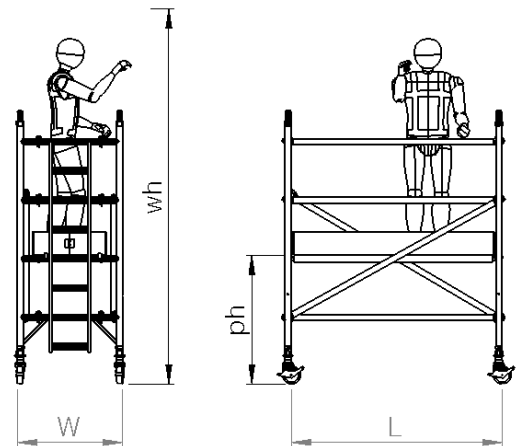

Technical information:

Base Dimensions:	(L)1.8m X (W)0.85m
Maximum Platform Height (ph):	9.2m
Maximum Working Height (wh):	11.2m
Maximum Working Load Per Platform:	275kg
Maximum Working Load Per Tower: (including tower weight)	950kg
Weight:	328.0kg

Example picture of a 1450 1.8m 2.2m Platform Height GRP Tower

01227 860085
Mon-Fri, 8am until 5pm

For More Information:
info@towersandpodiums.co.uk
We reply within 1 hour
Mon-Fri, 8am until 5pm



UTS SALES AND REPAIRS

A SAFER WAY TO REACH NEW HEIGHTS

Single Width Tower
1.8m Long x 0.85m Wide

Working Height
11.7m

Platform Height
9.7m

Tower Components

Item	Description	Quantity
1	Locking Caster	4
2	Adjustable Leg	4
3	2 Rung Ladder Frame	1
4	2 Rung Span Frame	1
5	3 Rung Ladder Frame	1
6	3 Rung Span Frame	1
7	4 Rung Ladder Frame	4
8	4 Rung Span Frame	4
9	1.8m Trapdoor Platform	5
10	1.8m Fixed Platform	0
11	1.8m Horizontal Brace	22
12	2.1m Diagonal Brace	18
13	Small Stabiliser	0
14	Large Stabiliser	4
15	Folding Toeboard	1

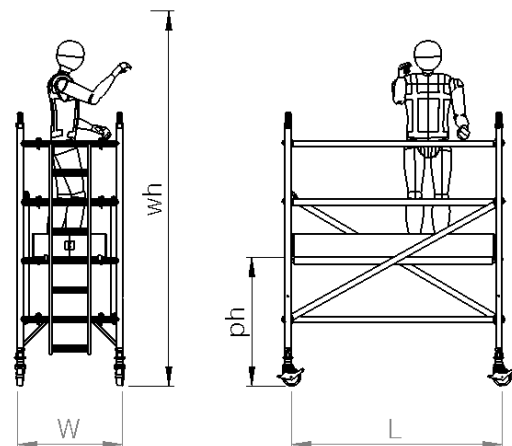

Technical information:

Base Dimensions:	(L)1.8m X (W)0.85m
Maximum Platform Height (ph):	9.7m
Maximum Working Height (wh):	11.7m
Maximum Working Load Per Platform:	275kg
Maximum Working Load Per Tower: (including tower weight)	950kg
Weight:	336.0kg

Example picture of a 1450 1.8m 2.2m Platform Height GRP Tower

01227 860085
Mon-Fri, 8am until 5pm

For More Information:
info@towersandpodiums.co.uk
We reply within 1 hour
Mon-Fri, 8am until 5pm



UTS SALES AND REPAIRS

A SAFER WAY TO REACH NEW HEIGHTS

Single Width Tower
1.8m Long x 0.85m Wide

Working Height
12.2m

Platform Height
10.2m

Tower Components

Item	Description	Quantity
1	Locking Caster	4
2	Adjustable Leg	4
3	2 Rung Ladder Frame	1
4	2 Rung Span Frame	1
5	3 Rung Ladder Frame	0
6	3 Rung Span Frame	0
7	4 Rung Ladder Frame	5
8	4 Rung Span Frame	5
9	1.8m Trapdoor Platform	5
10	1.8m Fixed Platform	0
11	1.8m Horizontal Brace	22
12	2.1m Diagonal Brace	19
13	Small Stabiliser	0
14	Large Stabiliser	4
15	Folding Toeboard	1

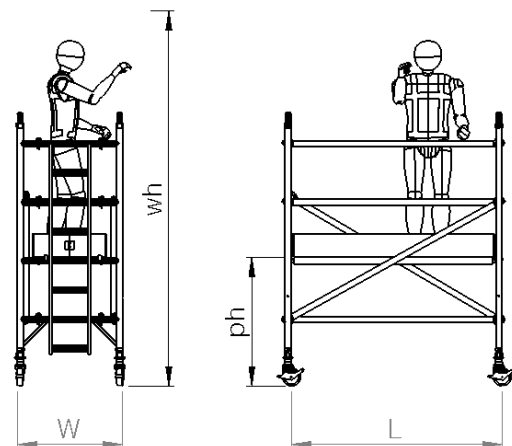

Technical information:

Base Dimensions:	(L)1.8m X (W)0.85m
Maximum Platform Height (ph):	10.2m
Maximum Working Height (wh):	12.2m
Maximum Working Load Per Platform:	275kg
Maximum Working Load Per Tower: (including tower weight)	950kg
Weight:	343.6kg

Example picture of a 1450 1.8m 2.2m Platform Height GRP Tower

01227 860085
Mon-Fri, 8am until 5pm

For More Information:
info@towersandpodiums.co.uk
We reply within 1 hour
Mon-Fri, 8am until 5pm



UTS SALES AND REPAIRS

A SAFER WAY TO REACH NEW HEIGHTS

Single Width Tower
1.8m Long x 0.85m Wide

Working Height
12.7m

Platform Height
10.7m

Tower Components

Item	Description	Quantity
1	Locking Caster	4
2	Adjustable Leg	4
3	2 Rung Ladder Frame	0
4	2 Rung Span Frame	0
5	3 Rung Ladder Frame	1
6	3 Rung Span Frame	1
7	4 Rung Ladder Frame	5
8	4 Rung Span Frame	5
9	1.8m Trapdoor Platform	5
10	1.8m Fixed Platform	0
11	1.8m Horizontal Brace	22
12	2.1m Diagonal Brace	20
13	Small Stabiliser	0
14	Large Stabiliser	4
15	Folding Toeboard	1

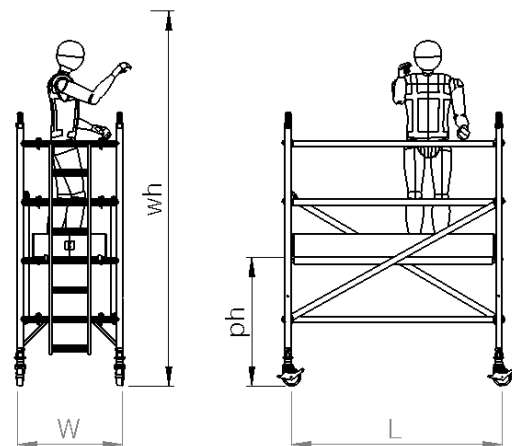

Technical information:

Base Dimensions:	(L)1.8m X (W)0.85m
Maximum Platform Height (ph):	10.7m
Maximum Working Height (wh):	12.7m
Maximum Working Load Per Platform:	275kg
Maximum Working Load Per Tower: (including tower weight)	950kg
Weight:	349.9kg

Example picture of a 1450 1.8m 2.2m Platform Height GRP Tower

01227 860085
Mon-Fri, 8am until 5pm

For More Information:
info@towersandpodiums.co.uk
We reply within 1 hour
Mon-Fri, 8am until 5pm



UTS SALES AND REPAIRS

A SAFER WAY TO REACH NEW HEIGHTS

Single Width Tower
1.8m Long x 0.85m Wide

Working Height
13.2m

Platform Height
11.2m

Tower Components

Item	Description	Quantity
1	Locking Caster	4
2	Adjustable Leg	4
3	2 Rung Ladder Frame	0
4	2 Rung Span Frame	0
5	3 Rung Ladder Frame	0
6	3 Rung Span Frame	0
7	4 Rung Ladder Frame	6
8	4 Rung Span Frame	6
9	1.8m Trapdoor Platform	6
10	1.8m Fixed Platform	0
11	1.8m Horizontal Brace	26
12	2.1m Diagonal Brace	21
13	Small Stabiliser	0
14	Large Stabiliser	4
15	Folding Toeboard	1

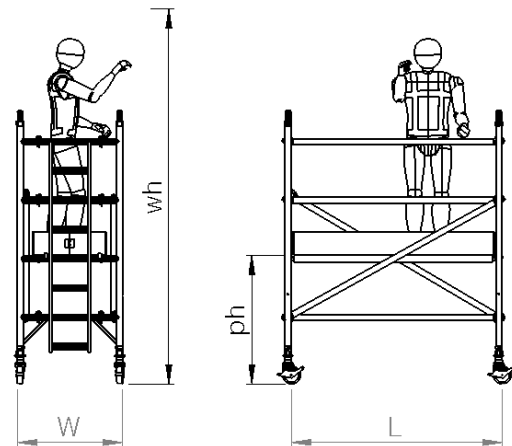

Technical information:

Base Dimensions:	(L)1.8m X (W)0.85m
Maximum Platform Height (ph):	11.2m
Maximum Working Height (wh):	13.2m
Maximum Working Load Per Platform:	275kg
Maximum Working Load Per Tower: (including tower weight)	950kg
Weight:	384.1kg

Example picture of a 1450 1.8m 2.2m Platform Height GRP Tower

01227 860085
Mon-Fri, 8am until 5pm

For More Information:
info@towersandpodiums.co.uk
We reply within 1 hour
Mon-Fri, 8am until 5pm



UTS SALES AND REPAIRS

A SAFER WAY TO REACH NEW HEIGHTS

Single Width Tower
1.8m Long x 0.85m Wide

Working Height
13.7m

Platform Height
11.7m

Tower Components

Item	Description	Quantity
1	Locking Caster	4
2	Adjustable Leg	4
3	2 Rung Ladder Frame	1
4	2 Rung Span Frame	1
5	3 Rung Ladder Frame	1
6	3 Rung Span Frame	1
7	4 Rung Ladder Frame	5
8	4 Rung Span Frame	5
9	1.8m Trapdoor Platform	6
10	1.8m Fixed Platform	0
11	1.8m Horizontal Brace	26
12	2.1m Diagonal Brace	22
13	Small Stabiliser	0
14	Large Stabiliser	4
15	Folding Toeboard	1

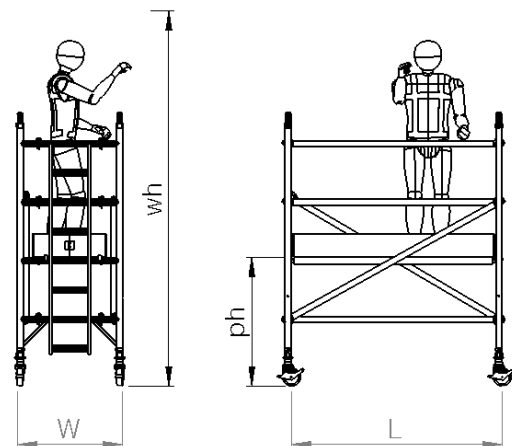

Technical information:

Base Dimensions:	(L)1.8m X (W)0.85m
Maximum Platform Height (ph):	11.7m
Maximum Working Height (wh):	13.7m
Maximum Working Load Per Platform:	275kg
Maximum Working Load Per Tower: (including tower weight)	950kg
Weight:	392.2kg

Example picture of a 1450 1.8m 2.2m Platform Height GRP Tower

01227 860085
Mon-Fri, 8am until 5pm

For More Information:
info@towersandpodiums.co.uk
We reply within 1 hour
Mon-Fri, 8am until 5pm



UTS SALES AND REPAIRS

A SAFER WAY TO REACH NEW HEIGHTS

Single Width Tower
1.8m Long x 0.85m Wide

Working Height
14.2m

Platform Height
12.2m

Tower Components

Item	Description	Quantity
1	Locking Caster	4
2	Adjustable Leg	4
3	2 Rung Ladder Frame	1
4	2 Rung Span Frame	1
5	3 Rung Ladder Frame	0
6	3 Rung Span Frame	0
7	4 Rung Ladder Frame	6
8	4 Rung Span Frame	6
9	1.8m Trapdoor Platform	6
10	1.8m Fixed Platform	0
11	1.8m Horizontal Brace	26
12	2.1m Diagonal Brace	23
13	Small Stabiliser	0
14	Large Stabiliser	4
15	Folding Toeboard	1

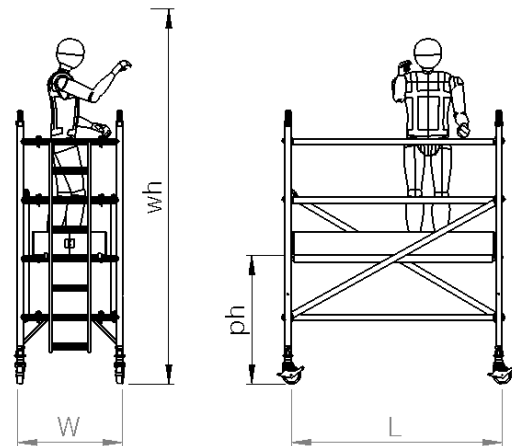

Technical information:

Base Dimensions:	(L)1.8m X (W)0.85m
Maximum Platform Height (ph):	12.2m
Maximum Working Height (wh):	14.2m
Maximum Working Load Per Platform:	275kg
Maximum Working Load Per Tower: (including tower weight)	950kg
Weight:	399.7kg

Example picture of a 1450 1.8m 2.2m Platform Height GRP Tower

01227 860085
Mon-Fri, 8am until 5pm

For More Information:
info@towersandpodiums.co.uk
We reply within 1 hour
Mon-Fri, 8am until 5pm

